



Yu Hub Industrial Co., Ltd

No. 17-17, Lun Tzy Jai Rd., Ding Juang, Shi Hwu Chang Hua,
51448, Taiwan
TEL: +886-4-8811738
FAX: +886-4-8812386
Email: Info@wheelmate.com.tw

Wang Sheng Vietnam Industrial Co., Ltd

No.18 Rd., DT743, Lot 0, Song Than Industrail
Zone 2, Tan Dong Hiep Commune, Di An District,
Binh Doung Province, Vietnam
TEL: 06503.730389 06503.730390
FAX: 06503.730391
Email: wangsheng@hcm.vnn.vn

Taiwan Office
TEL: +886-4-8811641
FAX: +886-4-8817125
Email: auwang@ms61.hinet.net



www.yuhub.com.tw

2017 PRODUCTS GUIDE

Quality X Professional X Creative



THE HIGHEST QUALITY TO PRODUCTS

Develop X Design X Produce

Yu Hub, founded in 1982, and was dedicated ourselves in production of hubs of bicycles, tricycles, and wheelchairs professionally. Mr. Huang, the president pays a lot attention on the training, learning, and work-spirit in duty of employees. The most important principles of Yu Hub are “the highest quality to products” and “the perfect service for customers.” Over 30years producing experience in hubs combined with the high-tech equipments makes Yu Hub a most reliable hub manufacturer.

Our producing equipments include: the newest CNC lathe machines, press machines, punch machines, hydraulic machines, rotary waging machines and steel tube cutting machines. More than that, in order to remain the best quality of our productions, we use the latest standard-type universal testing machine and the wheel hub durability testing machine to examine the products.

For promoting the ability of competition in 2000 market, Yu Hub expand our factories overseas to Vietnam. So far, the productivity of our factories is increasing from 350000 pairs per month to 800000 pairs per month. Since, not only the best products Yu Hub could offer you but also the best price. The insistence we hold, the best you get.

Made in Vietnam.

STEEL HUB P.37

PARTS P.31

RIM & SPOKE P.35

Made in Vietnam.



INDEX

BMX P.03

MTB P.09

CITY & ROAD P.17

FREEWHEEL P.25

SPECIAL HUB P.27

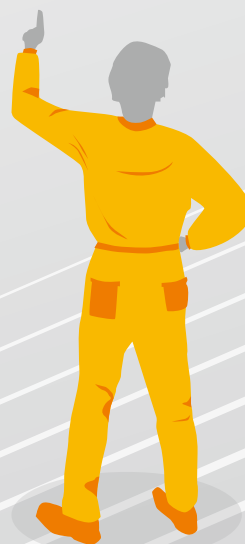
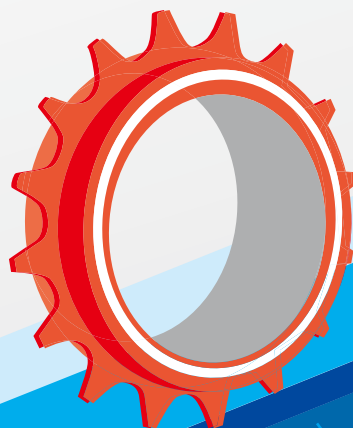
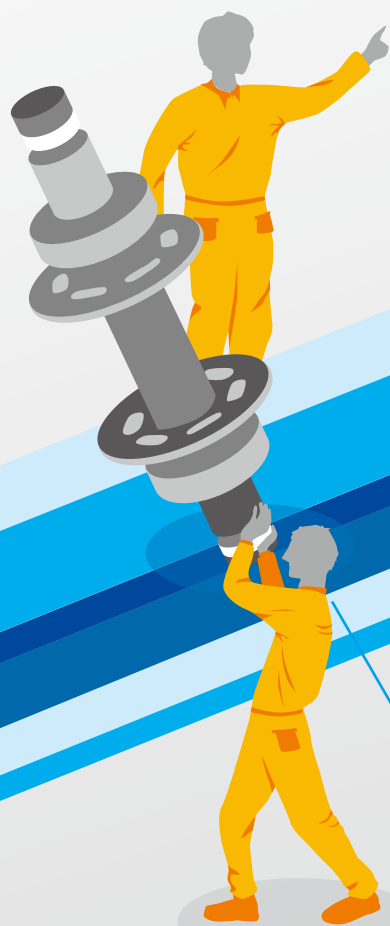



BR-02R *NEW*

holes	36H
spec	M10*110W, 13~ 16T available 6 pawls alloy shimano cassette
FREE BODY	6 pawls 72 clicks
Flange PCD	58mm/45mm
s.bearing	4
Weight/g	267



BR-02F *NEW*

holes	36H
spec	M15*100W
FREE BODY	X
Flange PCD	45mm
s.bearing	2
Weight/g	182

spec
 ■ ADAPTER FOR BR-02F
 FOR M20*100W spec



F-S03R *NEW*

holes	36H
spec	M14*110W
FREE BODY	6 pawls 9 tooth 24 clicks
Flange PCD	58/54mm
s.bearing	3+1 needle
Weight/g	411

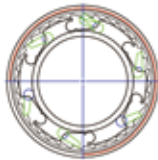

F-S04R *NEW*

holes	36H
spec	M14*110W
FREE BODY	6 pawls 9 tooth 72 clicks
Flange PCD	58/54mm
s.bearing	3+1 needle
Weight/g	411



BR-01R

holes	36H
spec	3/8&M10*110W, 13~ 16T available 3 pawls alloy shimano cassette
FREE BODY	3 pawls 24 clicks
Flange PCD	47mm
s.bearing	4
Weight/g	229



BR-01F

holes	36H
spec	M20*100W W/AXLE AND BOLT FOR BR-01F $\phi 20^* \phi 15^* M10^* 115$ AXLE AND BOLT FOR BR-01F
FREE BODY	X
Flange PCD	47mm
s.bearing	2
Weight/g	156

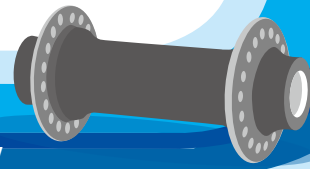

RC-F18

holes	36H
spec	M10*100W, axle 7075AL W/screw M10*P1.5*30L*2pcs CP finished
FREE BODY	X
Flange PCD	38mm
s.bearing	2
Weight/g	125



RC-R18

holes	36H
spec	M10*110W, axle 7075AL W/screw M10*P1.5*30L*2pcs CP finished
FREE BODY	1.37" & M30 threaded
Flange PCD	45mm
s.bearing	3
Weight/g	146



F-S31R

holes	36H
spec	3/8*110mm, axle CRMO SNCM21, solid bolt type 3/8-24T*17H*40L, Allen key for 8mm. W/Adaptor for 14mm M14*110*119L,axle CRMO SNCM21, solid bolt type 3/8-24T*17H*40L, Allen key for 8mm.
FREE BODY	3 pawls 9 tooth 1speed
Flange PCD	47mm
s.bearing	4
Weight/g	298/303

F-S31F

holes	36H
spec	3/8*100mm, axle AL7075, alloy end cap 7075 solid bolt type 3/8-24T*17H*40L, Allen key for 8mm. crmo axle available
FREE BODY	X
Flange PCD	38mm
s.bearing	2
Weight/g	124



F-S31RH

holes	36H
spec	M14*110W*170L, axle crmo SNCM 21
FREE BODY	3 pawls 9 tooth 1 speed
Flange PCD	47mm
s.bearing	4
Weight/g	319





F-S01R(K)

holes	36/48H
spec	M14*110*175mm, axle CRMO 6mm hollow Forged FN M14*P1.0*19H*15.5L
FREE BODY	6 pawls 9 tooth 1 speed
Flange PCD	58mm/45mm
s.bearing	5
Weight/g	531

F-S02F

holes	32/36H
spec	3/8*100*165mm, axle CRMO, alloy end cap 7075 CNC FN 3/8-26T*17H*20L (Crmo end cap available)
FREE BODY	X
Flange PCD	38mm
s.bearing	2
Weight/g	185.5



YH-253FB

holes	36H
spec	3/8*100mm*145/155/165L, CRMO axle Forged FN 3/8-26T*15*11L
FREE BODY	X
Flange PCD	38mm
s.bearing	2
Weight/g	229

YH-253FBA

holes	36H
spec	3/8*100mm*145/155/165L, CRMO axle, 6061alloy end cap Forged FN 3/8-26T*15*11L
FREE BODY	X
Flange PCD	38mm
s.bearing	2
Weight/g	205



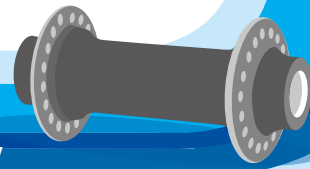

F-S05R

holes 36/48H
 spec M14*110*180mm, axle CRMO solid,
 Loose ball
 Option-LHD/RHD
FREE BODY 6 pawls 9 tooth 1 speed
Flange PCD 58mm/45mm
s.bearing X
Weight/g 598



F-C01RM Freecoaster

holes 36/48H
 spec M14*110*175L, ANOD,
 hollow 6mm axle CRMO
FREE BODY Option-LHD/RHD
 9 tooth 1 speed
Flange PCD 58mm
s.bearing 4
Weight/g 610



F-C01RF Freecoaster

holes 36/48H
 spec M14*110*119L, ANOD, bolt type
FREE BODY Option-LHD/RHD
 9 tooth 1 speed
Flange PCD 58mm
s.bearing 4
Weight/g 557



F-C01R38 Freecoaster

holes 36/48H
 spec 3/8"*110*160/180L, axle CRMO solid, ANOD
FREE BODY Option-LHD/RHD
 9 tooth 1 speed
Flange PCD 58mm
s.bearing 4
Weight/g 520



YH-216R

holes	36/48H
spec	3/8"*110/112mm (M14 available)
FREE BODY	1.37" threaded
Flange PCD	68mm
s.bearing	X
Weight/g	360



YH-215F

holes	36/48H
spec	3/8"*100mm (M14 available)
FREE BODY	X
Flange PCD	68mm
s.bearing	X
Weight/g	330



YH-230R

holes	36/48H
spec	3/8"*110/112mm
FREE BODY	1.37" threaded
Flange PCD	45mm
s.bearing	X
Weight/g	336



YH-229F

holes	36/48H
spec	3/8"*100m
FREE BODY	X
Flange PCD	45mm
s.bearing	X
Weight/g	310

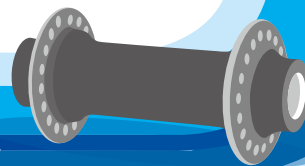

T-R11

holes 28/32H
spec M10*110*126L,disc,
 Axle 7075, end cap 7075AL,
 w/end cap 8mm*2pcs for OLD 116mm,
 w/screw M6*P1.O*30L*2PCS

FREE BODY 1.37" threaded
Flange PCD 58mm/45mm
s.bearing 2
Weight/g 164



T-R12

holes 28/32H
spec M10*129*145L,disc,
 Axle 7075, end cap 7075AL,
 w/end cap 8mm*2pcs for OLD 135mm,
 w/screw M6*P1.O*30L*2PCS

FREE BODY 1.37" threaded
Flange PCD 58mm/45mm
s.bearing 2
Weight/g 164

T-R13

holes 28/32H
spec M10*129*145L,non disc, Axle 7075,
 end cap 7075AL,
 w/end cap 8mm*2pcs for OLD 135mm,
 w/screw M6*P1.O*30L*2PCS

FREE BODY 1.37" threaded
Flange PCD 58mm
s.bearing 2
Weight/g 198





DC-F27 *NEW*

holes 32H
 spec M15*110W
 FREE BODY X
 Flange PCD 58/45mm
 s.bearing 2
 Weight/g 144
 Boost MTB

DC-R27 *NEW*

holes 32H
 spec M12*148W
 FREE BODY 3 pawls alloy shimano 8-11S cassette,
 Sram 11S available
 Flange PCD 58/58mm
 s.bearing 4
 Weight/g 294
 Boost MTB



DC-F23 *NEW*

holes 28/32/36H
 spec M15*100, W/O axle, disc
 FREE BODY x
 Flange PCD 45/58mm
 s.bearing 2
 Weight/g 156



spec
 ▪ End cap set for M9*100

DC-R30 *NEW*

holes 32/36H
 spec M10*135W
 FREE BODY 6 pawls, 72 clicks, alloy 8-10S
 Cassette, SRAM XX1 available
 Flange PCD 58mm
 s.bearing 4
 Weight/g 315



spec
 ▪ End cap set for 135-10
 ▪ End cap set for 135-12
 ▪ End cap set for 142-12

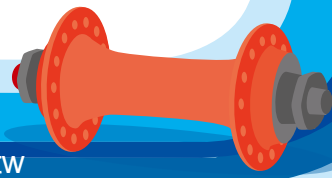

DC-F07

holes 32/36H
 spec M20*110,
 W/O axle, disc
 FREE BODY x
 Flange PCD 58mm
 s.bearing 2
 Weight/g 198

spec

- End cap set for QR typed
- End cap set for 100-9
- End cap set for 100-15
- End cap set for 110-20

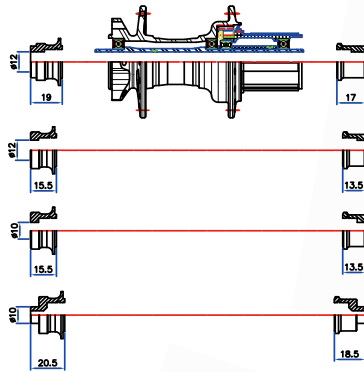
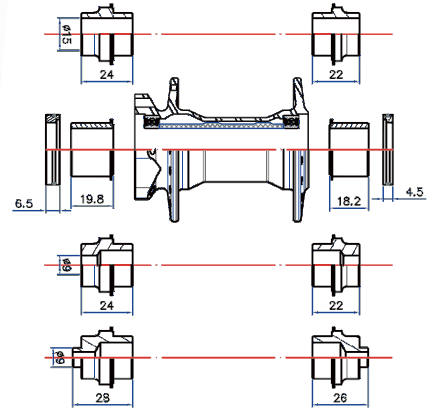

DC-R23

holes 32/36H
 spec M10*135W, axle AL7075
 M12*135W, axle AL7075
 M12*142W, axle AL7075

FREE BODY 6 pawls, 48 clicks,
 steel 8-10S
 Cassette

s.bearing 4
 Weight/g 344



DC-R08W

holes 28/32H
 spec M10*135, axle AL7075
 FREE BODY 3 pawls alloy shimano 8-10 S Cassette
 Flange PCD 47mm/58mm
 s.bearing 4
 Weight/g 276



DC-F02W

holes 28/32H
 spec M9*100, axle AL7075
 FREE BODY x
 Flange PCD 58mm/38mm
 s.bearing 2
 Weight/g 117



DC-R08

holes	28/32H
spec	M10*135, axle AL7075
FREE BODY	3 pawls alloy shimano 8-10 S Cassette
Flange PCD	47mm/58mm
s.bearing	4
Weight/g	281



DC-F02

holes	28/32H
spec	M9*100, axle AL7075
FREE BODY	x
Flange PCD	58mm/38mm
s.bearing	2
Weight/g	120

DC-R03

holes	28/32H
spec	M10*135, axle AL7075, cassette
FREE BODY	3 pawls steel 8-10 S Cassette
Flange PCD	58mm/45mm
s.bearing	2
Weight/g	422



DC-F03

holes	28/32H
spec	M9*100, axle AL7075
FREE BODY	x
Flange PCD	58mm/45mm
s.bearing	2
Weight/g	237



DC-R01

holes	28/32/36H
spec	M10*135, axle AL7075, cassette
FREE BODY	3 pawls steel 8-10 S Cassette
Flange PCD	58mm
s.bearing	2
Weight/g	445

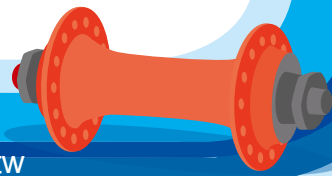

RC-R33

holes	24/28H
spec	M10*130/135mm, cassette, burnished loose ball
FREE BODY	3 pawls steel 8-10 S Cassette
Flange PCD	45mm
s.bearing	X
Weight/g	343



RC-F33

holes	24/28H
spec	M9*100, burnished loose ball
FREE BODY	x
Flange PCD	38mm
s.bearing	X
Weight/g	148



YH-218Q

holes	28/32/36H
spec	M10*130/135mm, cassette, loose ball
FREE BODY	3 pawls steel 8-10 S Cassette
Flange PCD	45mm
s.bearing	X
Weight/g	486



YH-220Q

holes	28/32/36H
spec	M10*130/135mm, threaded, loose ball
FREE BODY	1.37" threaded
Flange PCD	45mm
s.bearing	X
Weight/g	316

DC-F01

holes	28/32/36H
FREE BODY	x
Flange PCD	58mm
s.bearing	2
Weight/g	241





YH-220R

holes	20/28/32/36H
spec	3/8*126/130/135mm, nut-type, loose ball
FREE BODY	1.37" threaded
Flange PCD	45mm
s.bearing	X
Weight/g	316

YH-219Q

holes	20/28/32/36H
spec	M9*100*108mm, loose ball
FREE BODY	x
Flange PCD	38mm
s.bearing	X
Weight/g	158



YH-219F

holes	20/28/32/36H
spec	3/8*100mm, nut-type, loose ball
FREE BODY	x
Flange PCD	38mm
s.bearing	X
Weight/g	224

YH-256R

holes	28/32/36H
spec	3/8*126/130/135mm, nut-type, loose ball
FREE BODY	1.37" threaded
Flange PCD	45mm
s.bearing	X
Weight/g	330



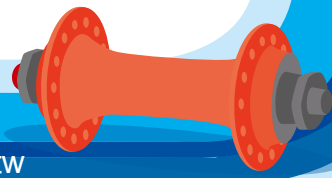

YH-255F

holes	20/28/32/36H
spec	3/8*100mm, nut-type, loose ball
FREE BODY	x
Flange PCD	38mm
s.bearing	X
Weight/g	215

YH-254R

holes	20/28/32/36H
spec	3/8*126/130/135mm, nut-type, loose ball
FREE BODY	1.37" threaded
Flange PCD	45mm
s.bearing	X
Weight/g	309



YH-253F

holes	20/28/32/36H
spec	3/8*100mm, nut-type, loose ball
FREE BODY	x
Flange PCD	38mm
s.bearing	X
Weight/g	214

YH-204R

holes	20/28/32/36H
spec	3/8*126/130/135mm, loose ball
FREE BODY	1.37" threaded
Flange PCD	45mm
s.bearing	X
Weight/g	257





YH-203F

holes	20/28/32/36H
spec	3/8*100mm, loose ball
FREE BODY	x
Flange PCD	38mm
s.bearing	X
Weight/g	160



YH-200Q

holes	24/28/32/36H
spec	M10*135mm, cassette, disc,, loose ball
FREE BODY	3 pawls steel 8-10 S Cassette
Flange PCD	58mm
s.bearing	X
Weight/g	476



YH-205Q

holes	24/28/32/36H
spec	M9*100*108mm, disc, loose ball
FREE BODY	x
Flange PCD	58mm
s.bearing	X
Weight/g	275

YH-206Q

holes	24/28/32/36H
spec	M10*135mm, disc, 7-8s, loose ball
FREE BODY	1.37" threaded
Flange PCD	58mm
s.bearing	X
Weight/g	330



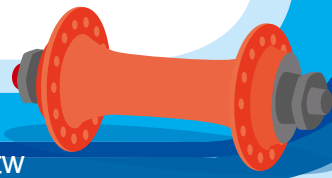

DC-F20

holes	36H
spec	M20*110W
FREE BODY	x
Flange PCD	47mm
s.bearing	2
Weight/g	156

DC-F08

holes	32/36H
spec	M20*110, W/O axle, for DH
FREE BODY	x
Flange PCD	58mm
s.bearing	2
Weight/g	184



YH-267F

holes	28/32H
spec	M20*110, W/O axle, for DH, disc
FREE BODY	x
Flange PCD	58mm
s.bearing	2
Weight/g	220



DC-R20

holes	32/36H
spec	3/8*135W,ALLOY axle, 9~11T, 6PAWLS driver, bolt typed
FREE BODY	6 pawls steel 1S
Flange PCD	58mm
s.bearing	4
Weight/g	334



RDC-F27 *NEW*

holes 24H
 spec M9*100W, M15*100W, axle AL7075
 FREE BODY x
 Flange PCD 54mm/58mm
 s.bearing 2
 Weight/g 149
 For cycle cross



RDC-R27W *NEW*

holes 24H
 spec M10*135W/M12*142W
 FREE BODY 6 pawls alloy shimano 11S cassette,
 72 clicks
 Flange PCD 58mm
 s.bearing 4
 Weight/g 268
 Round flange available for item RDC-R27
 For cycle cross



RC-R27W *NEW*

holes 24H
 spec M10*130W
 FREE BODY 6 pawls alloy shimano 11S cassette, 72 clicks
 Flange PCD 38/58mm
 s.bearing 4
 Weight/g 241
 Round flange available for item RC-R27



XRC-S11

holes 24H
 spec M10*130, axle AL7075,
 shimano 11S 7075AL cassette
 (hard anodized)
 W/Washer for 10 speed
 FREE BODY 3 pawls alloy shimano 11S Cassette,
 W/Washer for 10 speed,
 camp free body available
 s.bearing 4
 Weight/g 204



XRC-S11F

holes 24H
 spec M9*100, axle AL7075
 FREE BODY X
 s.bearing 2
 Weight/g 89



RC-S11

holes	24H
spec	M10*130, axle AL7075, shimano 11 S 7075AL cassette(hard anodized)
FREE BODY	38mm/52mm
Flange PCD	3 pawls alloy shimano 11S Cassette, W/Washer for 10 speed, camp free body available
s.bearing	4
Weight/g	212

RC-R35

holes	24/28H
spec	M10*130, axle AL7075, shimano 7075AL cassette 10S
FREE BODY	38mm/47mm
Flange PCD	3 pawls alloy shimano 10S Cassette, camp free body available
s.bearing	4
Weight/g	230



RC-F35

holes	20/24H
spec	M9*100, axle AL7075
FREE BODY	32mm
Flange PCD	X
s.bearing	2
Weight/g	77.5

XRC-R06

holes	24H
spec	M10*130, axle AL7075, shimano 7075AL cassette 10S
FREE BODY	3 pawls alloy shimano 10S Cassette, camp free body available
s.bearing	4
Weight/g	199.5





XRC-F06

holes 20H
 spec M9*100, axle AL7075
 FREE BODY X
 s.bearing 2
 Weight/g 76.5



XRC-F05

holes 20/24H
 spec M9*100, axle AL7075
 FREE BODY x
 s.bearing 2
 Weight/g 86

XRC-R03

holes 24/28H
 spec M10*130, axle AL7075, shimano 7075AL cassette 10S
 FREE BODY 3 pawls alloy shimano 10S Cassette, camp free body available
 s.bearing 4
 Weight/g 231



XRC-F03

holes 20/24H
 spec M9*100, axle AL7075
 FREE BODY X
 s.bearing 2
 Weight/g 81



RC-R31

holes	24/28/H
spec	M10*130/135, axle AL7075, cassette
Flange PCD	45mm
FREE BODY	3 pawls steel shimano 8-10S Cassette
s.bearing	2
Weight/g	340

RC-F31

holes	24/28/H
spec	M9*100*108, axle AL7075
Flange PCD	38mm
FREE BODY	X
s.bearing	2
Weight/g	102



XRC-F74

holes	20H
spec	M9*74W
FREE BODY	X
s.bearing	2
Weight/g	58



RC-F28

holes	20H
spec	<ul style="list-style-type: none"> ▪ M9*74, axle AL7075 ▪ M9*86, axle AL7075 ▪ M9*100, axle AL7075
Flange PCD	38mm
FREE BODY	X
s.bearing	2
Weight/g	86

RC-F01AB

holes	28/32/36H
spec	M9*100*108, axle AL7075, bolt type
Flange PCD	62mm
s.bearing	2
Weight/g	138



RC-R03AB

holes	28/32/36H
spec	M10*120/130mm, axle AL7075, bolt type
Flange PCD	62mm
FREE BODY	FIX+FREE
s.bearing	2
Weight/g	148





RC-R07

holes	28/32/36H
spec	M10*130, axle CRMO, 7S
Flange PCD	62mm
s.bearing	2
Weight/g	230



RC-R06

holes	28/32/36H
spec	M10*126, axle CRMO, 6S
Flange PCD	62mm
s.bearing	2
Weight/g	230

RC-F06

holes	28/32/36H
spec	M9*100, axle CRMO
Flange PCD	62mm
s.bearing	2
Weight/g	187





RC-F01

holes	28/32/36H
spec	M9*100*140mm, axle CRMO, nut-type
Flange PCD	62mm
s.bearing	2
Weight/g	238

RC-R02

holes	28/32/36H
spec	M10*120*166mm, axle CRMO, nut-type
Flange PCD	62mm
FREE BODY	FIX+FIX
s.bearing	2
Weight/g	271



RC-R03

holes	28/32/36H
spec	M10*120*166mm, axle CRMO, nut-type
Flange PCD	62mm
FREE BODY	FIX+FREE
s.bearing	2
Weight/g	271





RC-F08

holes	32H
spec	M9*100*145mm, axle CRMO, nut-type
Flange PCD	38mm
s.bearing	2
Weight/g	181.5



1.37"X24T-RH

1.29"X24T-LH

RC-R08

holes	32H
spec	M10*120*170mm, axle CRMO, nut-type FIX+FIX
Flange PCD	45mm
FREE BODY	FIX+FIX
s.bearing	2
Weight/g	242



1.29"X24T-LH

1.37"X24T-RH

1.37"X24T-RH

1.29"X24T-LH

RC-R23

holes	32H
spec	M10*120*170mm, axle CRMO, nut-type FIX+FREE
Flange PCD	45mm
FREE BODY	FIX+FREE
s.bearing	2
Weight/g	242



1.37"X24T-RH



FREEWHEEL



BMX RACING FREEWHEEL

90.6B

spec 6pawls-16tooth,ED finished alloy and crmo material available sealed bearing

Weight/g 143
REMARKS 90 clicks

TRIAL FREEWHEELS

TFW-135.9B

spec 9pawls-16/17/18 tooth, ED finished sealed bearing

Weight/g 134
REMARKS 135 clicks



BFW-F9-108B

spec 9pawls-16/17/18 tooth, ED finished sealed bearing

Weight/g 140
REMARKS 108 clicks



TRIAL FREEWHEELS

BFW-F6-16T

spec 6pawls-16tooth, ED finished

Weight/g 163
REMARKS 72 clicks

BFW-F6-18T

spec 6pawls-18tooth, ED finished

Weight/g 176
REMARKS 72 clicks

BFW-F6-17T

spec 6pawls-17tooth, ED finished

Weight/g 170
REMARKS 72 clicks



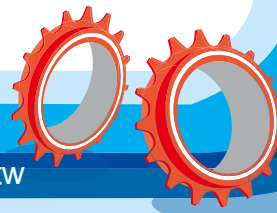

TRIAL FREEWHEELS

BFW-F9-16T

spec 9pawls-16tooth,ED finished
 Weight/g 163
 REMARKS 108 clicks

BFW-F9-17T

spec 9pawls-17tooth,ED finished
 Weight/g 170
 REMARKS 108 clicks

BFW-F9-18T

spec 9pawls-18tooth,ED finished
 Weight/g 176
 REMARKS 108 clicks

TRIAL FREEWHEELS

BFW-30.6

spec

- 6pawls-16tooth,ED finished
- 6pawls-17tooth,ED finished
- 6pawls-18tooth,ED finished

 Weight/g 176
 REMARKS 30 clicks



E-BIKE

F9-4arm

spec ED finished
 REMARKS 108 clicks

F6-4arm

spec ED finished
 REMARKS 72 clicks

30.6-4arm

spec ED finished
 REMARKS 30 clicks





SPECIAL HUB

WHEEL CHAIR HUB



WS-280

holes 28/32/36H
spec HUB shell & black cap, 14G, W/R8 (28.575*12.7*7.9)BEARING*2, or 6001(28*12*8) wheelchair W/O axle&QR



WS-286

holes 28/32/36H
spec 14G, cold forged alloy with sealed bearing, for wheelchair, W/O axle&QR

WS-400

holes 36H
spec 5/8*178, 12G, Cart hub, CP
Weight/g 917



WS-400A

spec cart hub, 5/8*178mm, axle set



WS-400C

spec cart hub, cone 5/8", 1PC

WS-400B

spec cart hub, cup, a/41mm, b/17mm, c/59mm, 1PC

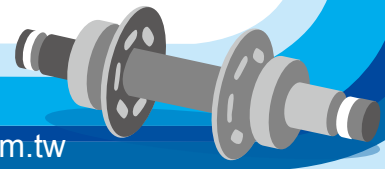

WS-344A

holes 36H
spec 12/14G, CP/ED, steel,
for tricycle, PCD:71mm

WS-344B

spec 6202-2RS bearing*2PCS

WS-282

holes 20/28/36/48H
spec W/O bearing & M10*P1.25*
10mm nut, 178L axle
Weight/g 403

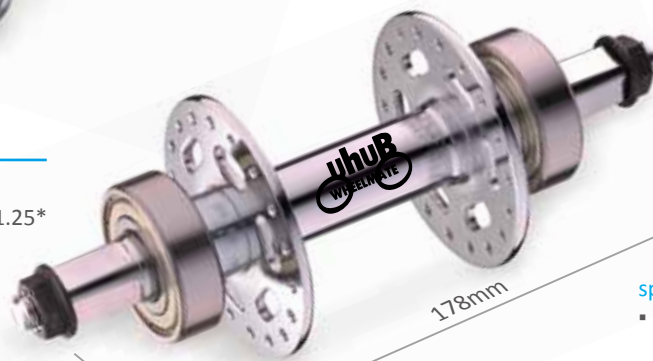

spec
▪ 6203-2RS bearing*2
OD40*ID17*12W



WS-282-1

holes 20/28/36/48H
spec M8*P1.0*18mm screw, 157L axle
Weight/g 403

spec
▪ 6203-2RS bearing*2
OD40*ID17*12W

WS-282-4

holes 36/48H
spec CRMO ISIS 158L,
W/O bearing &
W/O screw

Weight/g 605



spec
▪ Optional:sealed bearing 60/22 or
6004/22
▪ Optional:Screw M12*P1.0 or
M15*1.0



SPECIAL HUB



WS-282-5

holes 36/48H
 spec CRMO ISIS 158L,
 W/O bearing &
 W/O screw
 Weight/g 374

spec

- Optional:sealed bearing 60/22 or 6004/22
- Optional:Screw M12*P1.0 or M15*1.0



MA-01FD For Trike bike

holes 32/36H
 spec OLD 100W, axle length 158L
 W/Bearing 6003-2RS*2PCS (inside hub)
 W/Bearing 6203-2RS*2PCS (on axle)
 PCD 58mm
 W/Bolt M8*P1.0*18L*2pcs
 3 pawls inside for pedaling
 Weight/g 629

MA-01F For Trike bike

holes 32/36H
 spec OLD 100W, axle length 158L
 W/Bearing 6003-2RS*2PCS (inside hub)
 W/Bearing 6203-2RS*2PCS (on axle)
 PCD 58mm
 W/Bolt M8*P1.0*18L*2pcs
 3 pawls inside for pedaling
 Weight/g 656



DC-F25

holes 32/36H
 spec M15*135W, axle 7075
 Flange PCD 58mm
 s.bearing 2SB
 Weight/g 211

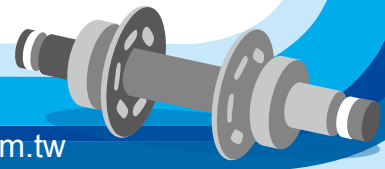

DC-F26

holes	32/36H
spec	M15*150W, axle 7075
Flange PCD	58mm
s.bearing	2SB
Weight/g	225



DC-R25

holes	32/36H
spec	M10/12*170W, axle 7075, shimano 10s cassette
Flange PCD	58mm
s.bearing	4SB
Weight/g	325



DC-R26

holes	32/36H
spec	M10/12*190W, axle 7075, shimano 10s cassette
Flange PCD	58mm
s.bearing	4SB
Weight/g	340

D-S05F

holes	24/28/32/36H
spec	M14*100, axle CRMO, nut-type
Flange PCD	58mm
s.bearing	2
Weight/g	346.5



D-S15R

holes	32H/36H
spec	13G, for Tricycle hub, hub shell only
Flange PCD	58mm
s.bearing	X
Weight/g	360



CSTSA0H004

spec shimano 11 speed freebody, Titanium forged, 3 pawls with springs and sealed bearing
FOR XRC-S11/RC-S11



CS7SA0H003

spec shimano 11 speed freebody, hard anodized, alloy 7075 forged, 3 pawls with springs and sealed bearing
FOR XRC-S11/RC-S11



CS7CA0H003

spec campy 11 speed freebody, hard anodized, alloy 7075 forged, 3 pawls with springs and sealed bearing
FOR XRC-S11/RC-S11





For DC-R27

FREE BODY Alloy Sram 11S cassette



GUARD-029

weight/g/pc 74

GUARD-030

weight/g/pc 71



HUB Guard List

Item number	Spec	Material	For hub item	Noted
Guard-014	Ψ55*Ψ15*12	7075	F-S31F	
Guard-018	Ψ74*Ψ14*14.5	7075	F-S31R	DS
Guard-019	Ψ68*Ψ14*21.5	6061	F-S31R	NDS
Guard-029	Ψ68*Ψ14*20	7075	F-S01R(K)/ F-S31R	NDS
Guard-030	Ψ75*Ψ22*21	7075	F-S01R(K)/F-C01R38/F-C01RM/F-C01RF	DS





10CR

Alloy 6061 rear skewer quick release
weight/g/pc 53



11AR

Alloy 6061 rear skewer quick release
weight/g/pc 20

10CF

Alloy 6061 front skewer quick release
weight/g/pc 53

11AF

Alloy 6061 front skewer quick release
weight/g/pc 20



10BR

Alloy 6061 rear skewer quick release
weight/g/pc 45

10BF

Alloy 6061 front skewer quick release
weight/g/pc 45

WS-108

Front Axle set
5/16" x 130, 135, 140mm

WS-109

Rear Axle for quick release
M10 x 136, 140, 145mm



WS-110

Rear Axle for quick release
M9 x 108mm

WS-105

Rear hub axle, for MTB

WS-106

Rear hub axle, for BMX



WS-107

Front Axle set
3/8" x 138, 135, 140mm



16T COG

FOR FIX GEAR USE
UCP FINISHED
Cog 1.37"*24T Right threaded
locking 1.29"*24T Left threaded
Pressed made
For chain 1/2"*1/8"
Available for 16T/18T
Material Steel
For Fix Gear

CS7AMS001

spec 10 Speed shimano free body, anodized matt silver.
Alloy 7075 forged.
3 pawls with spring and sealed bearing
6902-2RS*2pcs assembled.
weight/g/pc 79

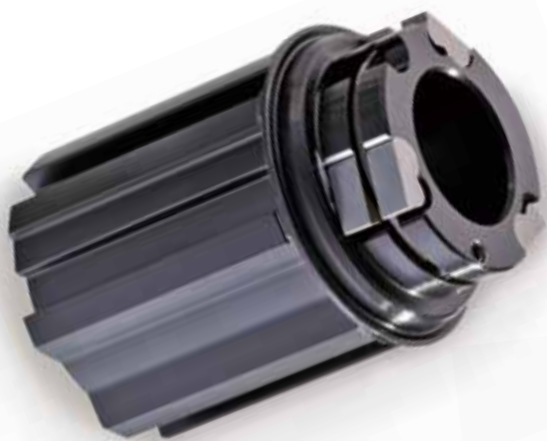

CS7AFB001

spec 10 Speed camy free body, anodized matt black.
Alloy 7075 forged.
3 pawls with spring and sealed bearing
6802-2RS*2pcs assembled.
weight/g/pc 69

Anodized color chips





RIM & SPOKE

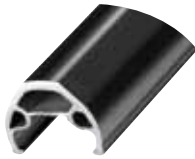
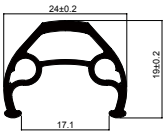

A-17

size 20"/24"/26"/700C
(1.5-1.95 Available)
holes 20/24/28/32/36H
Guage 12/13/14G
Finish Anodized or power coating
Joint Pinned
6061-T6 forged

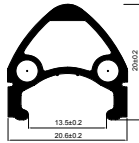

A-20

size 20"/24"/26"/700C
(1.5-1.95 Available)
holes 20/24/28/32/36H
Guage 12/13/14G
Finish Anodized or power coating
Joint Pinned
6061-T6 forged

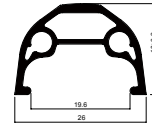

A-26

size 20"/24"/26"/700C
(1.5-1.95 Available)
holes 20/24/28/32/36H
Guage 12/13/14G
Finish Anodized or power coating
Joint Pinned
6061-T6 forged

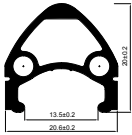

A-250

size 20"/24"/26"/700C
(1.5-1.95 Available)
holes 20/24/28/32/36H
Guage 12/13/14G
Finish Anodized or power coating
Joint Pinned
6061-T6 forged

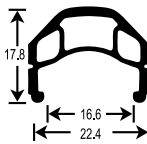

A-130

size 20"/24"/26"/700C
(1.5-1.95 Available)
holes 20/24/28/32/36H
Guage 12/13/14G
Finish Anodized or power coating
Joint Pinned
6061-T6 forged

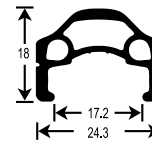

A-150

size 20"/24"/26"
(1.5-1.95 Available)
holes 16/20/28/32/36/48H
Guage 12/13/14G
Finish Anodized or power coating
Joint Pinned
6061-T6 forged

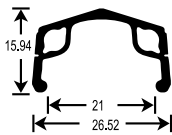

WS-6NS

size 12"/16"/20"/24"/26" (1.5-1.95 Available)
holes 16/20/28/36/48H
Guage 12/13/14G
Finish Anodized or power coating
Joint Pinned
6061-T6 forged

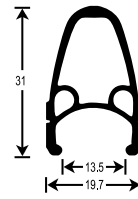

A-160

size 20"/24"/26"/700C (1.5-1.95 Available)
holes 16/20/28/32/36/48H
Guage 12/13/14G
Finish Anodized or power coating
Joint Pinned
6061-T6 forged

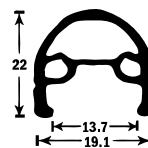

A-140

size 20"/24"/26"/700C
(1.5-1.95 Available)
holes 24/32/36H
Guage 14G
Finish Anodized or power coating
with CNC on the wall
Joint Pinned
6061-T6 forged

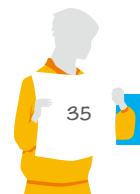



WS-6N

size 12"/16"/20"/24"/26"
(1.5-1.95 Available)
holes 16/20/28/36/48H
Gauge 12/13/14G
Finish Anodized or power coating
Joint Pinned
6061-T6 forged



WS-6A

size 16"/20"/24"/26" x 13/8
holes 20/28/36/36H
Gauge 14G
Finish Anodized or power coating
Joint Pinned
6061-T6 forged

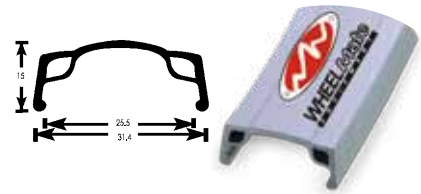

WS-7X

size 20"/24"/26"
(1.75-2.125 Available)
holes 28/36/48H
Gauge 12/13/14G
Finish Anodized or power coating
Joint Pinned
6061-T6 forged



A-100

size 20"/24"/26"/700C
(1.5-1.95 Available)
holes 24/32/36H
Gauge 14G
Finish Anodized or power coating
Joint Pinned with CNC on the wall
6061-T6 forged

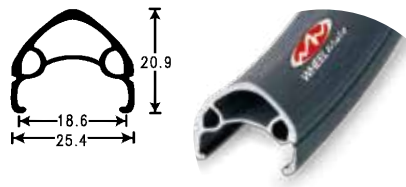

A-120

size 20"/24"/26"/700C
(1.5-1.95 Available)
holes 24/32/36H
Gauge 14G
Finish Anodized or power coating
Joint Pinned with CNC on the wall
6061-T6 forged



WS-10

size 12"/16"/20"/24"/26"
(1.5-1.95 Available)
holes 16/20/28/36H
Gauge 14G
Finish Anodized or power coating
Joint Pinned with CNC on the wall
6061-T6 forged

SPOLE				
Gauge No.	d	Threads per inch	ℓ	b
15	1.8	56	9.5	3.7
14	2.0	56	9.5	4.0
13	2.3	56	10	4.5
12	2.6	56	10	5.0
11	2.9	44	11	5.5
10	3.2	40	12	6
9	3.5	40	13	7.1

NIPPLE												
	A		B		C		D		E			
12	+0.5	0	4.0	+0.2	0	3.4	+0.2	0	6.5	0	-0.3	1.2
12	"	"	4.0	"	"	3.4	"	"	6.5	"	"	1.2
12.5	"	"	4.3	"	"	3.6	"	"	7.0	"	"	1.2
13.5	"	"	4.6	"	"	3.9	"	"	7.5	"	"	1.2
14.5	"	"	5.0	"	"	4.3	"	"	8.0	"	"	1.2
15	"	"	5.8	"	"	4.9	"	"	9.0	"	"	1.2
16	"	"	6.4	"	"	5.6	"	"	9.5	"	"	1.2

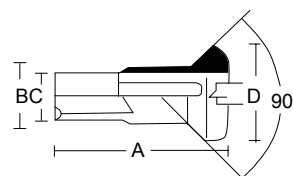
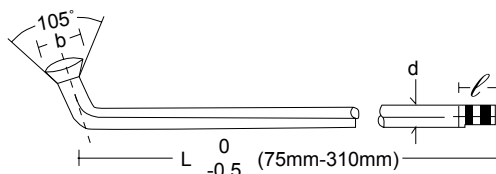



STEELHUB



WS-314R *NEW*

3/8*135
32/36/48/72H
6~7S
Ball bearing



WS-313F *NEW*

3/8*100
32/36/48/72H
Ball bearing



WS-336R

3/8*126/130/135
28/36H
6S~7S & 1 Speed
Ball bearing



WS-335F

5/16,3/8*100
20/28/36H
Ball bearing



WS-315R

3/8*93/100
28/36H
Ball bearing
Steel cold forged



WS-307F

5/16,3/8*100
28/36H
Ball bearing



WS-316R

3/8*126/130/135
36H
6S~7S
Ball bearing
Steel cold forged
1 Speed for WS-318R

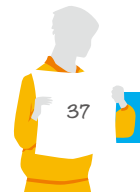



WS-322R

3/8*126/130/135
28/36H
5S~7S
Ball bearing



WS-321F

3/8*100
28/36H
Ball bearing



WS-311F

3/8*100
36/48H
Ball bearing



WS-309F

3/8*100
36/48H
Ball bearing
For BMX



WS-312R

3/8*110/112
1S
36/48H
Ball bearing



WS-327-1F

5/16,3/8*83/93
16/20/28H
Ball bearing



WS-327F

5/16,3/8*93/100
16/20/28/36H
Ball bearing

